

# COMMERCIAL WASHROOM ACCESSORIES



## Paper Towel Dispensers & Waste Bins

## Paper Towel Dispensers

## Waste Bins

## Soap Dispensers

## Toilet Roll Holders

## Hooks & Soap Dish

## Shelves

## Mirrors

JD MacDonald's product portfolio includes an extensive washroom accessories range as their standard items. Should these not meet all your project requirements JD MacDonald has an extended non standard range which includes; janitorial accessories, health care accessories and security accessories.

To view these non standard items, along with more product options for shelves, shower seats, soap dispensers, traditional, simplicity and profile collections please visit [www.americanspecialties.com](http://www.americanspecialties.com)

JD MacDonald reserves the right to, and does from time to time, make changes and improvements in design and dimensions. The photographs & descriptions of the products in this catalogue are representational only. All dimensions are in millimetres.

Freecall 1800 023 441 or phone your nearest JD MacDonald Sales Office

Adelaide (08) 8168 2222, Brisbane (07) 3363 6400, Melbourne (03) 9271 6400, Perth (08) 9271 8455, Sydney (02) 9756 1622

A Division of MacDonald Johnston Pty Ltd 65-73 Nantilla Road, Clayton North, Victoria 3168 Tel (03) 9271 6400 Fax (03) 9271 6485

# COMMERCIAL WASHROOM ACCESSORIES

## Paper Towel Dispensers & Waste Bins



0462-AD

Recessed Paper Towel Dispenser & Waste Bin (Traditional Collection)



Fabricated of grade 304 stainless steel and shall dispense 475 standard multi-fold paper towels.  
Waste capacity: 7.6 litres.  
Rough wall opening: 325 x 670 x 110mm.

**0462-AD-9** (not shown) same as 0462-AD, except with stainless steel collar for surface mounting.

0467

Recessed Paper Towel Dispenser & Waste Bin (Traditional Collection)



Fabricated of grade 304 stainless steel and shall dispense 800 standard multi-fold paper towels.  
Waste capacity: 22.7 litres.  
Rough wall opening: 290 x 1360 x 160mm.

**0467-9** (not shown) same as 0467, except with stainless steel collar for surface mounting.

0469

Recessed Paper Towel Dispenser & Waste Bin (Traditional Collection)



Fabricated of grade 304 stainless steel and shall dispense 800 standard multi-fold paper towels.  
Waste capacity: 46 litres.  
Rough wall opening: 400 x 1390 x 102mm.

**0469-9** (not shown) same as 0469, except with stainless steel collar for surface mounting.

JD Macdonald reserves the right to, and does from time to time, make changes and improvements in design and dimensions. The photographs & descriptions of the products in this catalogue are representational only. All dimensions are in millimetres.

Freecall 1800 023 441 or phone your nearest JD Macdonald Sales Office

Adelaide (08) 8168 2222, Brisbane (07) 3363 6400, Melbourne (03) 9271 6400, Perth (08) 9271 8455, Sydney (02) 9756 1622

A Division of Macdonald Johnston Pty Ltd 65-73 Nantilla Road, Clayton North, Victoria 3168 Tel (03) 9271 6400 Fax (03) 9271 6485

# COMMERCIAL WASHROOM ACCESSORIES

## Paper Towel Dispensers & Waste Bins



6462

Recessed Paper Towel Dispenser & Waste Bin (Simplicity Collection)



Fabricated of grade 304 stainless steel and shall dispense 800 standard multi-fold paper towels.  
Waste capacity: 34 litres.  
Rough wall opening: 400 x 1335 x 150mm.

**6462-9** (not shown) same as 6462, except with stainless steel collar for surface mounting.

64623

Recessed Paper Towel Dispenser & Waste Bin (Simplicity Collection)



Fabricated of grade 304 stainless steel and shall dispense 475 standard multi-fold paper towels.  
Waste capacity: 8.4 litres.  
Rough wall opening: 324 x 673 x 102mm.

**64623-9** (not shown) same as 64623, except with stainless steel collar for surface mounting.

6467

Recessed Paper Towel Dispenser & Waste Bin (Simplicity Collection)



Fabricated of grade 304 stainless steel and shall dispense 800 standard multi-fold paper towels.  
Waste capacity: 18.9 litres.  
Rough wall opening: 290 x 1360 x 102mm.

**6467-9** (not shown) same as 6467, except with stainless steel collar for surface mounting.

JD MacDonald reserves the right to, and does from time to time, make changes and improvements in design and dimensions. The photographs & descriptions of the products in this catalogue are representational only. All dimensions are in millimetres.

Freecall 1800 023 441 or phone your nearest JD Macdonald Sales Office

Adelaide (08) 8168 2222, Brisbane (07) 3363 6400, Melbourne (03) 9271 6400, Perth (08) 9271 8455, Sydney (02) 9756 1622

A Division of Macdonald Johnston Pty Ltd 65-73 Nantilla Road, Clayton North, Victoria 3168 Tel (03) 9271 6400 Fax (03) 9271 6485

# COMMERCIAL WASHROOM ACCESSORIES

## Paper Towel Dispensers & Waste Bins



64676

Recessed Paper Towel Dispenser & Waste Bin (Simplicity Collection)



Fabricated of grade 304 stainless steel and shall dispense 800 standard multi-fold paper towels.  
Waste capacity: 26.5 litres.  
Rough wall opening: 290 x 1360 x 160mm.

**64676-9** (not shown) same as 64676, except with stainless steel collar for surface mounting.

9469

Recessed Paper Towel Dispenser & Waste Bin (Profile Collection)



Fabricated of grade 304 stainless steel and shall dispense 800 standard multi-fold paper towels.  
Waste capacity: 50.4 litres.  
Rough wall opening: 400 x 1384 x 102mm.

94623

Recessed Paper Towel Dispenser & Waste Bin (Profile Collection)



Fabricated of grade 304 stainless steel and shall dispense 475 standard multi-fold paper towels.  
Waste capacity: 7.6 litres.  
Rough wall opening: 324 x 673 x 108mm.

JD Macdonald reserves the right to, and does from time to time, make changes and improvements in design and dimensions. The photographs & descriptions of the products in this catalogue are representational only. All dimensions are in millimetres.

Freecall 1800 023 441 or phone your nearest JD Macdonald Sales Office

Adelaide (08) 8168 2222, Brisbane (07) 3363 6400, Melbourne (03) 9271 6400, Perth (08) 9271 8455, Sydney (02) 9756 1622

A Division of Macdonald Johnston Pty Ltd 65-73 Nantilla Road, Clayton North, Victoria 3168 Tel (03) 9271 6400 Fax (03) 9271 6485

# COMMERCIAL WASHROOM ACCESSORIES

## Paper Towel Dispensers & Waste Bins



1001

Counter Top Paper Towel Dispenser & Waste Bin (Traditional Collection)



Fabricated of grade 304 stainless steel and shall dispense C-fold paper towels.  
Waste capacity: 28 litres.  
Counter top opening: 318 x 380mm.

20469

Recessed Paper Towel Dispenser & Waste Bin (Roval Collection)



Fabricated of grade 304 stainless steel and shall dispense 800 standard multi-fold paper towels.  
Waste capacity: 56 litres.  
Rough wall opening: 397 x 1381 x 102mm.

204623

Recessed Paper Towel Dispenser & Waste Bin (Roval Collection)



Fabricated of grade 304 stainless steel and shall dispense 475 standard multi-fold paper towels.  
Waste capacity: 11.2 litres.  
Rough wall opening: 286 x 672 x 100mm.

JD Macdonald reserves the right to, and does from time to time, make changes and improvements in design and dimensions. The photographs & descriptions of the products in this catalogue are representational only. All dimensions are in millimetres.

Freecall 1800 023 441 or phone your nearest JD Macdonald Sales Office

Adelaide (08) 8168 2222, Brisbane (07) 3363 6400, Melbourne (03) 9271 6400, Perth (08) 9271 8455, Sydney (02) 9756 1622

A Division of Macdonald Johnston Pty Ltd 65-73 Nantilla Road, Clayton North, Victoria 3168 Tel (03) 9271 6400 Fax (03) 9271 6485

# COMMERCIAL WASHROOM ACCESSORIES

## Paper Towel Dispensers



0210

Surface Mounted Paper Towel Dispenser (Traditional Collection)



Fabricated of grade 304 stainless steel and shall dispense 525 standard multi-fold paper towels without adjustment or adapters.  
Overall size: 280 x 370 x 102mm.

0215

Surface Mounted Paper Towel Dispenser (Traditional Collection)



Fabricated of grade 304 stainless steel and shall dispense 275 standard multi-fold paper towels.  
Overall size: 280 x 205 x 102mm.

0245-SS

Surface Mounted Paper Towel Dispenser (Traditional Collection)



Fabricated of grade 304 stainless steel and shall dispense 400 single-fold paper towels.  
Overall size: 285 x 285 x 142mm.

JD MacDonald reserves the right to, and does from time to time, make changes and improvements in design and dimensions. The photographs & descriptions of the products in this catalogue are representational only. All dimensions are in millimetres.

Freecall 1800 023 441 or phone your nearest JD MacDonald Sales Office

Adelaide (08) 8168 2222, Brisbane (07) 3363 6400, Melbourne (03) 9271 6400, Perth (08) 9271 8455, Sydney (02) 9756 1622

A Division of MacDonald Johnston Pty Ltd 65-73 Nantilla Road, Clayton North, Victoria 3168 Tel (03) 9271 6400 Fax (03) 9271 6485

# COMMERCIAL WASHROOM ACCESSORIES

## Paper Towel Dispensers



0452

Recessed Paper Towel Dispenser (Traditional Collection)



Fabricated of grade 304 stainless steel and shall dispenses 800 standard multi-fold paper towels. Rough wall opening: 325 x 670 x 110mm.

**0452-9** (not shown) same as 0452, except with stainless steel collar for surface mounting.

8165

Surface Mounted Roll Paper Towel Holder (Traditional Collection)



Fabricated of die cast aluminium with satin matte silver-grey finish and shall dispense all standard core roll paper towels up to 152mm in diameter. Overall size: 330 x 45 x 102mm.

0258-SS

Surface Mounted Facial Tissue Dispenser



Fabricated of grade 304 stainless steel and shall dispense 300 single or 150 two-ply sheets. Overall size: 260 x 125 x 55mm.

JD MacDonald reserves the right to, and does from time to time, make changes and improvements in design and dimensions. The photographs & descriptions of the products in this catalogue are representational only. All dimensions are in millimetres.

Freecall 1800 023 441 or phone your nearest JD MacDonald Sales Office

Adelaide (08) 8168 2222, Brisbane (07) 3363 6400, Melbourne (03) 9271 6400, Perth (08) 9271 8455, Sydney (02) 9756 1622

A Division of MacDonald Johnston Pty Ltd 65-73 Nantilla Road, Clayton North, Victoria 3168 Tel (03) 9271 6400 Fax (03) 9271 6485

# COMMERCIAL WASHROOM ACCESSORIES

## Paper Towel Dispensers



6457

Recessed Paper Towel Dispenser (Simplicity Collection)



Fabricated of grade 304 stainless steel and shall dispense 475 standard multi-fold paper towels.  
Rough wall opening: 290 x 400 x 110mm.

9452

Recessed Paper Towel Dispenser (Profile Collection)



Fabricated of grade 304 stainless steel and shall dispense 800 standard multi-fold paper towels.  
Rough wall opening: 325 x 675 x 110mm.

1002

Counter Top Paper Towel Dispenser (Traditional Collection)



Fabricated of grade 304 stainless steel and shall dispense C-fold paper towels. Towels loaded by pushing downward through hinged dispensing flaps.  
Counter top opening: 362 x 152mm.

JD MacDonald reserves the right to, and does from time to time, make changes and improvements in design and dimensions. The photographs & descriptions of the products in this catalogue are representational only. All dimensions are in millimetres.

Freecall 1800 023 441 or phone your nearest JD MacDonald Sales Office

Adelaide (08) 8168 2222, Brisbane (07) 3363 6400, Melbourne (03) 9271 6400, Perth (08) 9271 8455, Sydney (02) 9756 1622

A Division of MacDonald Johnston Pty Ltd 65-73 Nantilla Road, Clayton North, Victoria 3168 Tel (03) 9271 6400 Fax (03) 9271 6485

# COMMERCIAL WASHROOM ACCESSORIES

## Paper Towel Dispensers



JDM-ROLL-DISP Surface Mounted Roll Paper Towel Dispenser



Fabricated of mild steel with a brilliant white powder coated finish and shall dispense all standard core roll paper towels up to 19mm wide.  
Overall size: 222 x 282 x 178mm.

20452 Recessed Paper Towel Dispenser (Roval Collection)



Fabricated of grade 304 stainless steel and shall dispense 800 standard multi-fold paper towels.  
Rough wall opening: 286 x 672 x 100mm.

JD Macdonald reserves the right to, and does from time to time, make changes and improvements in design and dimensions. The photographs & descriptions of the products in this catalogue are representational only. All dimensions are in millimetres.

Freecall 1800 023 441 or phone your nearest JD Macdonald Sales Office

Adelaide (08) 8168 2222, Brisbane (07) 3363 6400, Melbourne (03) 9271 6400, Perth (08) 9271 8455, Sydney (02) 9756 1622

A Division of Macdonald Johnston Pty Ltd 65-73 Nantilla Road, Clayton North, Victoria 3168 Tel (03) 9271 6400 Fax (03) 9271 6485

0458

Semi-Recessed Waste Bin (Traditional Collection)



Fabricated of grade 304 stainless steel and shall have hemmed edges for safety and interior hooks for liner.

Waste capacity: 46 or 68 litres.

Rough wall opening: 400 x 740mm

**0458-9** (not shown) same as 0458, except with stainless steel collar for surface mounting.

0825

Surface Mounted Large Capacity Waste Bin (Traditional Collection)



Fabricated of grade 304 stainless steel and shall have hemmed edges for safety and interior hooks for liner.

Waste capacity: 75.7 litres.

Overall size: 400 x 555 x 300mm

**0826** (not shown) same as 0825, except with 45.4 litre capacity.

Overall size: 390 x 585 x 200mm.

0827

Surface Mounted Small Capacity Waste Bin (Traditional Collection)



Fabricated of grade 304 stainless steel and shall have hemmed edges for safety.

Waste capacity: 7.6 litres.

Overall size: 275 x 230 x 110mm.

JD MacDonald reserves the right to, and does from time to time, make changes and improvements in design and dimensions. The photographs & descriptions of the products in this catalogue are representational only. All dimensions are in millimetres.

Freecall 1800 023 441 or phone your nearest JD MacDonald Sales Office

Adelaide (08) 8168 2222, Brisbane (07) 3363 6400, Melbourne (03) 9271 6400, Perth (08) 9271 8455, Sydney (02) 9756 1622

A Division of MacDonald Johnston Pty Ltd 65-73 Nantilla Road, Clayton North, Victoria 3168 Tel (03) 9271 6400 Fax (03) 9271 6485

0828

### Surface Mounted Medium Capacity Waste Bin (Traditional Collection)



Fabricated of grade 304 stainless steel and shall have hemmed edges for safety and interior hooks for liner.

Waste Capacity: 25.5 litres.

Overall size: 355 x 430 x 165mm.

0829

### Surface Mounted Corner Waste Bin (Traditional Collection)



Fabricated of grade 304 stainless steel and shall have hemmed edges for safety and interior hook for disposable bag.

Waste capacity: 59 litres.

Overall size: 380 x 585 x 370mm.

9474

### Recessed Waste Bin (Profile Collection)



Fabricated of grade 304 stainless steel.

No visible welding or open seams.

Interior stainless steel waste bin.

Waste capacity: 53 litres.

Rough wall opening: 400 x 980 x 160mm.

JD Macdonald reserves the right to, and does from time to time, make changes and improvements in design and dimensions. The photographs & descriptions of the products in this catalogue are representational only. All dimensions are in millimetres.

Freecall 1800 023 441 or phone your nearest JD Macdonald Sales Office

Adelaide (08) 8168 2222, Brisbane (07) 3363 6400, Melbourne (03) 9271 6400, Perth (08) 9271 8455, Sydney (02) 9756 1622

A Division of Macdonald Johnston Pty Ltd 65-73 Nantilla Road, Clayton North, Victoria 3168 Tel (03) 9271 6400 Fax (03) 9271 6485

### 0810 Free Standing Waste Bin (Traditional Collection)



Fabricated of grade 304 stainless steel and shall have top with self-closing doors and vinyl wall bumpers top and bottom, rubber feet and internal hooks for liner.

Waste capacity: 54 litres.

Overall size: 330 x 775 x 311mm.

**0812** (not shown) same as 0810, except 72 litre capacity. Overall size: 330 x 980 x 311mm.

### 0811 Free Standing Waste Bin (Traditional Collection)



Fabricated of grade 304 stainless steel and shall have vinyl wall bumpers top and bottom, rubber feet and internal hooks for liner.

Waste capacity: 54 litres.

Overall size: 330 x 560 x 311mm.

**0813** (not shown) same as 0811, except 72 litre capacity. Overall size: 330 x 760 x 311mm.

### 0852 Surface Mounted Sanitary Napkin Disposal



Fabricated of grade 304 stainless steel and shall have sloping cover with full length piano hinge.

Overall size: 190 x 246 x 102mm.

JD Macdonald reserves the right to, and does from time to time, make changes and improvements in design and dimensions. The photographs & descriptions of the products in this catalogue are representational only. All dimensions are in millimetres.

Freecall 1800 023 441 or phone your nearest JD Macdonald Sales Office

Adelaide (08) 8168 2222, Brisbane (07) 3363 6400, Melbourne (03) 9271 6400, Perth (08) 9271 8455, Sydney (02) 9756 1622

A Division of Macdonald Johnston Pty Ltd 65-73 Nantilla Road, Clayton North, Victoria 3168 Tel (03) 9271 6400 Fax (03) 9271 6485

9471

Recessed Sanitary Napkin Disposal (Profile Collection)



Fabricated of grade 304 stainless steel and shall have self-closing push-door covers disposal opening. Removable stainless steel waste bin.  
Waste capacity: 7.2 litres.  
Rough wall opening: 232 x 460 x 108mm.

1003

Counter Top Waste Access Door with Waste Bin



Fabricated of grade 304 stainless steel and shall receive waste into loose waste bin.  
Waste capacity: 28 litres.  
Counter top opening: 320 x 220mm.

1003-VM

Vertical Mount Waste Access Door with Waste Bin



Fabricated of grade 304 stainless steel and shall receive waste into loose waste bin.  
Waste capacity: 28 litres.  
Counter opening: 320 x 220mm.

JD Macdonald reserves the right to, and does from time to time, make changes and improvements in design and dimensions. The photographs & descriptions of the products in this catalogue are representational only. All dimensions are in millimetres.

Freecall 1800 023 441 or phone your nearest JD Macdonald Sales Office

Adelaide (08) 8168 2222, Brisbane (07) 3363 6400, Melbourne (03) 9271 6400, Perth (08) 9271 8455, Sydney (02) 9756 1622

A Division of Macdonald Johnston Pty Ltd 65-73 Nantilla Road, Clayton North, Victoria 3168 Tel (03) 9271 6400 Fax (03) 9271 6485

20470

Recessed Sanitary Napkin Disposal (Roval Collection)



Fabricated of grade 304 stainless steel and bin shall be formed seamless with bowed front face.  
Waste capacity: 3.7 litres.  
Rough wall opening: 289 x 244 x 102mm.

20852

Surface Mounted Sanitary Waste Bin (Roval Collection)



Fabricated of grade 304 stainless steel and bin shall be formed seamless with bowed front face.  
Waste capacity: 3.8 litres.  
Rough wall opening: 185 x 253 x 89mm.

20458

Semi-Recessed Waste Bin (Roval Collection)



Fabricated of grade 304 stainless steel and bin shall be formed seamless with bowed front face.  
Waste capacity: 42.6 litres.  
Rough wall opening: 400 x 660 x 100mm.

JD MacDonald reserves the right to, and does from time to time, make changes and improvements in design and dimensions. The photographs & descriptions of the products in this catalogue are representational only. All dimensions are in millimetres.

Freecall 1800 023 441 or phone your nearest JD MacDonald Sales Office

Adelaide (08) 8168 2222, Brisbane (07) 3363 6400, Melbourne (03) 9271 6400, Perth (08) 9271 8455, Sydney (02) 9756 1622

A Division of MacDonald Johnston Pty Ltd 65-73 Nantilla Road, Clayton North, Victoria 3168 Tel (03) 9271 6400 Fax (03) 9271 6485

# COMMERCIAL WASHROOM ACCESSORIES

## Soap Dispensers



0326

Recessed Soap Dispenser



Fabricated of grade 304 stainless steel and shall dispense 1.5 litres of liquid soap.  
Rough wall opening: 230 x 125 x 110mm.

0327

Recessed Soap Dispenser



Fabricated of grade 304 stainless steel and shall dispense 1 litre of liquid soap.  
Rough wall opening: 150 x 150 x 100mm.

6326

Recessed Soap Dispenser (Simplicity Collection)



Fabricated of grade 304 stainless steel and shall dispense 1.5 litres of liquid soap.  
Rough wall opening: 230 x 125 x 110mm.

JD MacDonald reserves the right to, and does from time to time, make changes and improvements in design and dimensions. The photographs & descriptions of the products in this catalogue are representational only. All dimensions are in millimetres.

Freecall 1800 023 441 or phone your nearest JD MacDonald Sales Office

Adelaide (08) 8168 2222, Brisbane (07) 3363 6400, Melbourne (03) 9271 6400, Perth (08) 9271 8455, Sydney (02) 9756 1622

A Division of MacDonald Johnston Pty Ltd 65-73 Nantilla Road, Clayton North, Victoria 3168 Tel (03) 9271 6400 Fax (03) 9271 6485

# COMMERCIAL WASHROOM ACCESSORIES

## Soap Dispensers



9326

Recessed Soap Dispenser (Profile Collection)



Fabricated of grade 304 stainless steel and shall dispense 1.5 litres of liquid soap.  
Rough wall opening: 230 x 125 x 110mm.

0345

Surface Mounted Horizontal Soap Dispenser



Fabricated of grade 304 stainless steel and shall dispense 1.2 litres of liquid soap.  
Overall size: 205 x 120 x 100mm.

0347

Surface Mounted Vertical Soap Dispenser



Fabricated of grade 304 stainless steel and shall dispense 1.2 litres of liquid soap.  
Overall size: 100 x 205 x 135mm.

JD MacDonald reserves the right to, and does from time to time, make changes and improvements in design and dimensions. The photographs & descriptions of the products in this catalogue are representational only. All dimensions are in millimetres.

Freecall 1800 023 441 or phone your nearest JD MacDonald Sales Office

Adelaide (08) 8168 2222, Brisbane (07) 3363 6400, Melbourne (03) 9271 6400, Perth (08) 9271 8455, Sydney (02) 9756 1622

A Division of MacDonald Johnston Pty Ltd 65-73 Nantilla Road, Clayton North, Victoria 3168 Tel (03) 9271 6400 Fax (03) 9271 6485

9343

Surface Mounted Soap Dispenser (Profile Collection)



Fabricated of grade 304 stainless steel and shall dispense 1.4 litres of liquid soap.  
Overall size: 185 x 165 x 94mm.

0332

Bench Mounted Soap Dispenser



Corrosion-resistant valve dispenses viscous lotion soaps and synthetic detergents. Fills from top for ease of maintenance. Adjustable threaded shank allows for installation in counter tops up to 90mm thick through 22mm diameter hole.

*Refer to JD MacDonalD specification sheet to view standard sizes available.*

0346

Surface Mounted Soap Dispenser with Vertical Valve



Fabricated of grade 304 stainless steel and shall dispense 1.18 litres of liquid soap. Valve mounted vertically from bottom of container for use in showers.

Overall size: 122 x 208 x 78mm.

JD MacDonalD reserves the right to, and does from time to time, make changes and improvements in design and dimensions. The photographs & descriptions of the products in this catalogue are representational only. All dimensions are in millimetres.

Freecall 1800 023 441 or phone your nearest JD MacDonalD Sales Office

Adelaide (08) 8168 2222, Brisbane (07) 3363 6400, Melbourne (03) 9271 6400, Perth (08) 9271 8455, Sydney (02) 9756 1622

A Division of MacDonalD Johnston Pty Ltd 65-73 Nantilla Road, Clayton North, Victoria 3168 Tel (03) 9271 6400 Fax (03) 9271 6485

0351

Surface Mounted Soap Dispenser



Stainless steel housing with mirror finish and removable plastic globe, concealed mounting. Shall dispense 0.4 litres of viscous lotion soaps or synthetic detergents.  
Overall size: 80 x 150 x 160mm.

**0352** (not shown) similar to 0351, except dispenses liquid soap in lather form. Use coconut base soap 10-20% concentrate only.

5001-SS

Surface Mounted Disposable Cartridge Soap Dispenser



Fabricated of grade 304 stainless steel and shall dispense 0.75 to 0.9 litres of liquid soap.  
Overall size: 110 x 280 x 100mm.

0340

Surface Mounted Liquid & Antiseptic Soap Dispenser



Fabricated of transparent smoked grey tank and opaque grey base, push bar and cover and shall dispense 1.18 litres of liquid soap.  
Overall size: 127 x 208 x 98mm.

JD MacDonald reserves the right to, and does from time to time, make changes and improvements in design and dimensions. The photographs & descriptions of the products in this catalogue are representational only. All dimensions are in millimetres.

Freecall 1800 023 441 or phone your nearest JD MacDonald Sales Office

Adelaide (08) 8168 2222, Brisbane (07) 3363 6400, Melbourne (03) 9271 6400, Perth (08) 9271 8455, Sydney (02) 9756 1622

A Division of MacDonald Johnston Pty Ltd 65-73 Nantilla Road, Clayton North, Victoria 3168 Tel (03) 9271 6400 Fax (03) 9271 6485

# COMMERCIAL WASHROOM ACCESSORIES

## Soap Dispensers



0350

Surface Mounted Surgical Soap Dispenser



Fabricated of a chrome plated brass body with internal stainless steel and plastic parts and shall dispense 0.5 litres of liquid soap.  
Overall size: 86 x 165 x 130mm.

2001

Surface Mounted ABS Soap Dispenser



Fabricated of ABS plastic and shall dispense 0.9 litres of liquid soap.  
Overall size: 115 x 235 x 95mm.

9305

Automatic ABS Touch Free Soap Dispenser



Fabricated of ABS plastic and shall dispense up to 0.8 litres of a commercial grade quality liquid soap (viscosity 35dPaxs). This unit has an infrared automatic sensor which gives 17,000 cycles on x6 AA Alkaline batteries.  
Overall size: 120 x 264 x 110mm.

JD Macdonald reserves the right to, and does from time to time, make changes and improvements in design and dimensions. The photographs & descriptions of the products in this catalogue are representational only. All dimensions are in millimetres.

Freecall 1800 023 441 or phone your nearest JD Macdonald Sales Office

Adelaide (08) 8168 2222, Brisbane (07) 3363 6400, Melbourne (03) 9271 6400, Perth (08) 9271 8455, Sydney (02) 9756 1622

A Division of Macdonald Johnston Pty Ltd 65-73 Nantilla Road, Clayton North, Victoria 3168 Tel (03) 9271 6400 Fax (03) 9271 6485

# COMMERCIAL WASHROOM ACCESSORIES

## Soap Dispensers



0360

Surface Mounted Stainless Steel Automatic Soap Dispenser



Fabricated of grade 304 stainless steel alloy 18-8 and black ABS and shall dispense 1 litre of liquid soap. This unit has an infrared automatic sensor which gives 17,000 cycles on x6 AAA Alkaline batteries. Overall size: 124 x 235 x 115mm.

V-320

Liquid Soap Valve

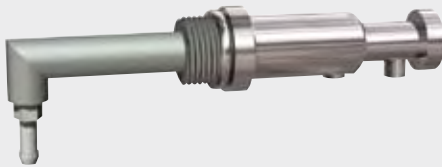

Fabricated of polished chrome plated brass and stainless steel. Derlin piston shall have a stainless steel push button. The V-320 replacement valve is for items 0326, 0327, 6326 and 9326.

V-321

Liquid Soap Valve



Fabricated of ABS plastic and stainless steel that will not corrode when exposed to soaps, lotions or detergents. The V-321 replacement valve is for items 0318, 0318A, 0345, 0347 and 9343.

JD MacDonald reserves the right to, and does from time to time, make changes and improvements in design and dimensions. The photographs & descriptions of the products in this catalogue are representational only. All dimensions are in millimetres.

Freecall 1800 023 441 or phone your nearest JD MacDonald Sales Office

Adelaide (08) 8168 2222, Brisbane (07) 3363 6400, Melbourne (03) 9271 6400, Perth (08) 9271 8455, Sydney (02) 9756 1622

A Division of MacDonald Johnston Pty Ltd 65-73 Nantilla Road, Clayton North, Victoria 3168 Tel (03) 9271 6400 Fax (03) 9271 6485

# COMMERCIAL WASHROOM ACCESSORIES

## Soap Dispensers



20364

Surface Mounted Stainless Steel Automatic Soap Dispenser (Roval Collection) 



Fabricated of grade 304 stainless steel alloy 18-8 and shall hold and dispense 1 litre of liquid soap. This unit has an infrared automatic sensor which gives 17,000 cycles on x6 AAA Alkaline batteries.

Overall size: 140 x 276 x 102mm

20333

Bench Mounted Automatic Soap Dispenser (Roval Collection)



Fabricated of grade 304 stainless steel alloy 18-8 and shall hold and dispense 1.6 litres of liquid soap. Spout shall have a polished finish over all exposed surface and chrome plated sensor housing. This unit sits at 86mm height above bench.

Total overall size: 102 x 546 x 150mm.

JD Macdonald reserves the right to, and does from time to time, make changes and improvements in design and dimensions. The photographs & descriptions of the products in this catalogue are representational only. All dimensions are in millimetres.

Freecall 1800 023 441 or phone your nearest JD Macdonald Sales Office

Adelaide (08) 8168 2222, Brisbane (07) 3363 6400, Melbourne (03) 9271 6400, Perth (08) 9271 8455, Sydney (02) 9756 1622

A Division of Macdonald Johnston Pty Ltd 65-73 Nantilla Road, Clayton North, Victoria 3168 Tel (03) 9271 6400 Fax (03) 9271 6485

# COMMERCIAL WASHROOM ACCESSORIES

## Toilet Roll Holders



0030

Double Toilet Roll Holder



Fabricated of grade 304 stainless steel and shall hold two standard toilet rolls. Top roll automatically drops in place when bottom roll is used up.  
Overall size: 152 x 305 x 165mm.

**0031** (not shown) similar to 0030, but provided with flange for recess mounting.  
Rough wall opening: 160 x 310 x 85mm.

9030

Double Toilet Roll Holder (Profile Collection)



Fabricated of grade 304 stainless steel and shall hold two standard toilet rolls. Top roll automatically drops in place when bottom roll is used up.  
Overall size: 152 x 305 x 159mm.

R-009

Theft Resistant Spindle



Fabricated of hi-impact ABS plastic and is available for the 7000 series toilet roll holders.

JD MacDonald reserves the right to, and does from time to time, make changes and improvements in design and dimensions. The photographs & descriptions of the products in this catalogue are representational only. All dimensions are in millimetres.

Freecall 1800 023 441 or phone your nearest JD MacDonald Sales Office

Adelaide (08) 8168 2222, Brisbane (07) 3363 6400, Melbourne (03) 9271 6400, Perth (08) 9271 8455, Sydney (02) 9756 1622

A Division of MacDonald Johnston Pty Ltd 65-73 Nantilla Road, Clayton North, Victoria 3168 Tel (03) 9271 6400 Fax (03) 9271 6485

# COMMERCIAL WASHROOM ACCESSORIES

## Toilet Roll Holders



0029

Triple Toilet Roll Holder



Fabricated of grade 304 stainless steel and shall hold three standard toilet rolls.  
Overall size: 120 x 425 x 125mm.

0040

Double Jumbo Toilet Roll Holder



Fabricated of grade 304 stainless steel and shall hold two 9" toilet rolls. When one roll is depleted, slide panel to expose other roll. Two viewing slots reveal toilet paper rolls inside.  
Overall size: 530 x 290 x 160mm.

0042

Single Jumbo Toilet Roll Holder



Fabricated of grade 304 stainless steel and shall hold one 9" toilet roll. Unit has viewing slot to reveal toilet paper roll inside.  
Overall size: 270 x 270 x 115mm.

JD Macdonald reserves the right to, and does from time to time, make changes and improvements in design and dimensions. The photographs & descriptions of the products in this catalogue are representational only. All dimensions are in millimetres.

Freecall 1800 023 441 or phone your nearest JD Macdonald Sales Office

Adelaide (08) 8168 2222, Brisbane (07) 3363 6400, Melbourne (03) 9271 6400, Perth (08) 9271 8455, Sydney (02) 9756 1622

A Division of Macdonald Johnston Pty Ltd 65-73 Nantilla Road, Clayton North, Victoria 3168 Tel (03) 9271 6400 Fax (03) 9271 6485

# COMMERCIAL WASHROOM ACCESSORIES

## Toilet Roll Holders



7402

Single Toilet Roll Holder



Fabricated of grade 304 stainless steel. Available as surface mount, recessed, bright or satin finish. Hooded or without hood. Overall size: 160 x 160mm.

*Refer to JD MacDonald specification sheet to view standard sizes available.*

74022

Double Toilet Roll Holder

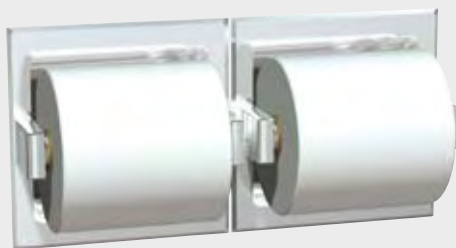

Fabricated of grade 304 stainless steel. Available as surface mount, recessed, bright or satin finish. Hooded or without hood. Overall size: 320 x 160mm.

*Refer to JD MacDonald specification sheet to view standard sizes available.*

0697-GAL

Double Toilet Roll Holder with Shelf



Fabricated of grade 304 stainless steel and shall hold two standard toilet paper rolls. Overall size: 460 x 130mm.

JD MacDonald reserves the right to, and does from time to time, make changes and improvements in design and dimensions. The photographs & descriptions of the products in this catalogue are representational only. All dimensions are in millimetres.

Freecall 1800 023 441 or phone your nearest JD MacDonald Sales Office

Adelaide (08) 8168 2222, Brisbane (07) 3363 6400, Melbourne (03) 9271 6400, Perth (08) 9271 8455, Sydney (02) 9756 1622

A Division of MacDonald Johnston Pty Ltd 65-73 Nantilla Road, Clayton North, Victoria 3168 Tel (03) 9271 6400 Fax (03) 9271 6485

# COMMERCIAL WASHROOM ACCESSORIES

## Toilet Roll Holders



7305-B

Single Toilet Roll Holder



Fabricated of grade 304 stainless steel bright finish with chrome-plated roller and shall hold one standard toilet roll.  
Overall size: 207 x 51 x 98mm.

**7305-S** (not shown) similar to 7305-B, but with satin finish.

7305-2B

Double Toilet Roll Holder



Fabricated of grade 304 stainless steel bright finish with chrome-plated roller and shall hold two standard toilet rolls.  
Overall size: 343 x 51 x 98mm.

**7305-2S** (not shown) similar to 7305-2B, but with satin finish.

0715

Double Toilet Roll Holder



Fabricated of grade 304 stainless steel in a high polish finish and shall hold two standard toilet rolls.  
Overall size: 283 x 70 x 105mm.

**0710** (not shown) similar to 0715, but shall hold one standard toilet roll.

JD MacDonald reserves the right to, and does from time to time, make changes and improvements in design and dimensions. The photographs & descriptions of the products in this catalogue are representational only. All dimensions are in millimetres.

Freecall 1800 023 441 or phone your nearest JD MacDonald Sales Office

Adelaide (08) 8168 2222, Brisbane (07) 3363 6400, Melbourne (03) 9271 6400, Perth (08) 9271 8455, Sydney (02) 9756 1622

A Division of MacDonald Johnston Pty Ltd 65-73 Nantilla Road, Clayton North, Victoria 3168 Tel (03) 9271 6400 Fax (03) 9271 6485

# COMMERCIAL WASHROOM ACCESSORIES

## Toilet Roll Holders



0263-1

Single Toilet Roll Holder



Fabricated of heavy-duty cast aluminium, satin matte silver-grey finish. No waste rocking action spindles of Cycolac ABS thermoplastic. Shall hold one standard toilet roll with controlled delivery. Overall size: 159 x 45 x 121mm.

**0263-12** (not shown) similar to 0263-1, but with vandal resistant spindle.

**0263-1A** (not shown) similar to 0263-1, but without controlled delivery.

0264-1

Double Toilet Roll Holder



Fabricated of heavy-duty cast aluminium, satin matte silver-grey finish. No waste rocking action spindles of Cycolac ABS thermoplastic. Shall hold two standard toilet rolls with controlled delivery. Overall size: 324 x 45 x 121mm.

**0264-12** (not shown) similar to 0264-1, but with vandal resistant spindle.

**0264-1A** (not shown) similar to 0264-1, but without controlled delivery.

**0264-1A2** (not shown) similar to 0264-1, but without controlled delivery and with vandal resistant spindle.

0266

Surface Mounted Vandal Proof Hood



Fabricated of grade 304 stainless steel for use only with 0263-1 series (specified and purchased separately). Overall size: 184 x 197 x 175mm.

**0267** same as 0266 but larger to fit 0264-1 series (double toilet roll holder). Overall size: 359 x 197 x 175mm.

JD MacDonald reserves the right to, and does from time to time, make changes and improvements in design and dimensions. The photographs & descriptions of the products in this catalogue are representational only. All dimensions are in millimetres.

Freecall 1800 023 441 or phone your nearest JD MacDonald Sales Office

Adelaide (08) 8168 2222, Brisbane (07) 3363 6400, Melbourne (03) 9271 6400, Perth (08) 9271 8455, Sydney (02) 9756 1622

A Division of MacDonald Johnston Pty Ltd 65-73 Nantilla Road, Clayton North, Victoria 3168 Tel (03) 9271 6400 Fax (03) 9271 6485

# COMMERCIAL WASHROOM ACCESSORIES

## Toilet Roll Holders



20031

Recessed Double Toilet Roll Holder (Roval Collection)



Fabricated of grade 304 stainless steel and shall hold and dispense two (2) standard toilet rolls. Top roll automatically drops in place when bottom roll is used up.  
Rough wall opening: 205 x 356 x 165mm

20030

Surface Mounted Double Toilet Roll Holder (Roval Collection)



Fabricated of grade 304 stainless steel and shall hold and dispense two (2) standard toilet rolls. Top roll automatically drops in place when bottom roll is used up.  
Overall size: 154 x 308 x 165mm

JD Macdonald reserves the right to, and does from time to time, make changes and improvements in design and dimensions. The photographs & descriptions of the products in this catalogue are representational only. All dimensions are in millimetres.

Freecall 1800 023 441 or phone your nearest JD Macdonald Sales Office

Adelaide (08) 8168 2222, Brisbane (07) 3363 6400, Melbourne (03) 9271 6400, Perth (08) 9271 8455, Sydney (02) 9756 1622

A Division of Macdonald Johnston Pty Ltd 65-73 Nantilla Road, Clayton North, Victoria 3168 Tel (03) 9271 6400 Fax (03) 9271 6485

[www.jdmacdonald.com.au](http://www.jdmacdonald.com.au)

0714

Coat Hook & Bumper



Fabricated of chrome plated brass and shall project 74mm from wall. Rubber bumper protects wall surface.

0751

Single Heavy Duty Robe Hook



Fabricated of brass with a satin chrome finish, concealed mounting and shall project 80mm from wall.

7340

Single Robe Hook



Fabricated of grade 304 stainless steel and shall extend 40mm from wall.

JD MacDonald reserves the right to, and does from time to time, make changes and improvements in design and dimensions. The photographs & descriptions of the products in this catalogue are representational only. All dimensions are in millimetres.

Freecall 1800 023 441 or phone your nearest JD MacDonald Sales Office

Adelaide (08) 8168 2222, Brisbane (07) 3363 6400, Melbourne (03) 9271 6400, Perth (08) 9271 8455, Sydney (02) 9756 1622

A Division of MacDonald Johnston Pty Ltd 65-73 Nantilla Road, Clayton North, Victoria 3168 Tel (03) 9271 6400 Fax (03) 9271 6485

7301

Single Towel Pin



Fabricated of grade 304 stainless steel and shall extend 90mm from wall.

7345

Double Robe Hook

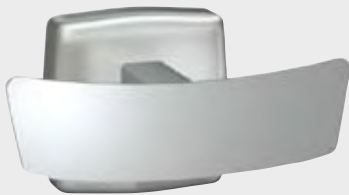

Fabricated of grade 304 stainless steel and shall extend 40mm from wall. 100mm bar forms hooks at each end.

7382

Hat & Coat Hook



Fabricated of grade 304 stainless steel and double hook for both coats and hats shall project 135 x 75mm.

JD MacDonald reserves the right to, and does from time to time, make changes and improvements in design and dimensions. The photographs & descriptions of the products in this catalogue are representational only. All dimensions are in millimetres.

Freecall 1800 023 441 or phone your nearest JD MacDonald Sales Office

Adelaide (08) 8168 2222, Brisbane (07) 3363 6400, Melbourne (03) 9271 6400, Perth (08) 9271 8455, Sydney (02) 9756 1622

A Division of MacDonald Johnston Pty Ltd 65-73 Nantilla Road, Clayton North, Victoria 3168 Tel (03) 9271 6400 Fax (03) 9271 6485

8425

Single Clothes Hook



Fabricated of grade 304 stainless steel with satin finish and shall project 32mm from wall and is 55mm high.

8215-3

Mop & Broom Holder Rack



Fabricated of grade 304 stainless steel and shall project 90mm from wall, have 3 holders and be 660mm long. Rubber cam holders ribbed for grasping.

**8215-4** (not shown) same as 8215-3, except 915mm long with 4 holders.

**8215-5** (not shown) same as 8215-3, except 1170mm long with 5 holders.

1307-3

Utility Hook Strip



Fabricated of grade 304 stainless steel and shall be 100mm high with edges returning 13mm to the wall, 660 long with 3 hooks.

**1307-4** (not shown) same as 1307-3, except 915mm long with 4 hooks.

**1307-5** (not shown) same as 1307-3, except 1170mm long with 5 hooks.

**1307-6** (not shown) same as 1307-3, except 1420mm long with 6 hooks.

JD MacDonald reserves the right to, and does from time to time, make changes and improvements in design and dimensions. The photographs & descriptions of the products in this catalogue are representational only. All dimensions are in millimetres.

Freecall 1800 023 441 or phone your nearest JD MacDonald Sales Office

Adelaide (08) 8168 2222, Brisbane (07) 3363 6400, Melbourne (03) 9271 6400, Perth (08) 9271 8455, Sydney (02) 9756 1622

A Division of MacDonald Johnston Pty Ltd 65-73 Nantilla Road, Clayton North, Victoria 3168 Tel (03) 9271 6400 Fax (03) 9271 6485

7320

Soap Dish with Drain Holes



Fabricated of grade 304 stainless steel. One-piece soap dish welded to support arm and flange with two drain holes. Overall size: 110 x 50 x 100mm.

7355

Round Towel Bar



Fabricated of grade 304 stainless steel and shall extend 80mm from wall. 19mm diameter towel bar available in 460, 610 & 760mm lengths.

0712

Retractable Clothes Line



Fabricated of grade 304 polished stainless steel and shall have spring actuated 1830mm vinyl cord with white vinyl knob and locking nut to hold stretched line taught. Installs over bathtub or in shower.

JD MacDonald reserves the right to, and does from time to time, make changes and improvements in design and dimensions. The photographs & descriptions of the products in this catalogue are representational only. All dimensions are in millimetres.

Freecall 1800 023 441 or phone your nearest JD MacDonald Sales Office

Adelaide (08) 8168 2222, Brisbane (07) 3363 6400, Melbourne (03) 9271 6400, Perth (08) 9271 8455, Sydney (02) 9756 1622

A Division of MacDonald Johnston Pty Ltd 65-73 Nantilla Road, Clayton North, Victoria 3168 Tel (03) 9271 6400 Fax (03) 9271 6485

0692

Surface Mounted Shelf Flat Top Series



Fabricated of grade 304 stainless steel and front edge shall be hemmed for maximum rigidity and safety.

*Refer to JD MacDonald specification sheet to view standard sizes available.*

0694

Surface Mounted Shelf



Fabricated of grade 304 stainless steel with satin finish on exposed surfaces and shall have 127mm depth.

*Refer to JD MacDonald specification sheet to view standard sizes available.*

7380

Surface Mounted Towel Shelf



Fabricated of grade 304 stainless steel and shall be available in 460 and 610mm lengths. Shelf, 125mm wide, extends 155mm from wall. Edges are roll-formed for safety.

*Refer to JD MacDonald specification sheet to view standard sizes available.*

JD MacDonald reserves the right to, and does from time to time, make changes and improvements in design and dimensions. The photographs & descriptions of the products in this catalogue are representational only. All dimensions are in millimetres.

Freecall 1800 023 441 or phone your nearest JD MacDonald Sales Office

Adelaide (08) 8168 2222, Brisbane (07) 3363 6400, Melbourne (03) 9271 6400, Perth (08) 9271 8455, Sydney (02) 9756 1622

A Division of MacDonald Johnston Pty Ltd 65-73 Nantilla Road, Clayton North, Victoria 3168 Tel (03) 9271 6400 Fax (03) 9271 6485

0535V2438 Fixed Framed Tilt Mirror



Frame fabricated of grade 304 stainless steel with satin finish. Mirror shall be tapered from 102mm at top to 5mm at bottom.  
Overall size: 610 x 960mm.

0600TV2438 Angle Adjustable Framed Tilt Mirror



Frame fabricated of grade 304 stainless steel with corners welded and ground smooth. Mirror shall tilt 152mm with bottom mounted on full width stainless steel piano hinge.  
Overall Size: 610 x 960mm.

0600V2438 Angle Framed Mirror



Frame fabricated of grade 304 stainless steel stainless steel and angle shall have corners Herliarc welded, ground and polished smooth to a uniform satin finish.  
Overall size: 610 x 960mm.

JD MacDonald reserves the right to, and does from time to time, make changes and improvements in design and dimensions. The photographs & descriptions of the products in this catalogue are representational only. All dimensions are in millimetres.

Freecall 1800 023 441 or phone your nearest JD MacDonald Sales Office

Adelaide (08) 8168 2222, Brisbane (07) 3363 6400, Melbourne (03) 9271 6400, Perth (08) 9271 8455, Sydney (02) 9756 1622

A Division of MacDonald Johnston Pty Ltd 65-73 Nantilla Road, Clayton North, Victoria 3168 Tel (03) 9271 6400 Fax (03) 9271 6485

0535V

Fixed Framed Tilt Mirror



Frame fabricated of grade 304 stainless steel and mirror shall be tapered from 102mm at top to 5mm at bottom.

**0537V** (not shown) same as 0535V but with shelf 152mm deep from wall.

*Refer to JD MacDonald specification sheet to view standard sizes available.*

0600TV

Adjustable Framed Tilt Mirror



Frame fabricated of grade 304 stainless steel with corners welded and ground smooth. Mirror shall tilt 152mm with bottom mounted on full width stainless steel piano hinge.

*Refer to JD MacDonald specification sheet to view standard sizes available.*

0600V

Angle Framed Mirror



Frame fabricated of grade 304 stainless steel and angle shall have corners Herliarc welded, ground and polished smooth to a uniform satin finish.

*Refer to JD MacDonald specification sheet to view standard sizes available.*

JD MacDonald reserves the right to, and does from time to time, make changes and improvements in design and dimensions. The photographs & descriptions of the products in this catalogue are representational only. All dimensions are in millimetres.

Freecall 1800 023 441 or phone your nearest JD MacDonald Sales Office

Adelaide (08) 8168 2222, Brisbane (07) 3363 6400, Melbourne (03) 9271 6400, Perth (08) 9271 8455, Sydney (02) 9756 1622

A Division of MacDonald Johnston Pty Ltd 65-73 Nantilla Road, Clayton North, Victoria 3168 Tel (03) 9271 6400 Fax (03) 9271 6485

0605V

Angle Framed Mirror with Shelf



Frame and shelf fabricated of grade 304 stainless steel and angle shall have corners Herliarc welded, ground and polished smooth to a uniform satin finish.

*Refer to JD MacDonalD specification sheet to view standard sizes available.*

0620V

Channel Framed Mirror



Frame fabricated of grade 304 stainless steel and channel is a one piece roll formed member that encases mirror and backing revealing a tight mitered corner.

*Refer to JD MacDonalD specification sheet to view standard sizes available.*

0625V

Channel Framed Mirror with Shelf

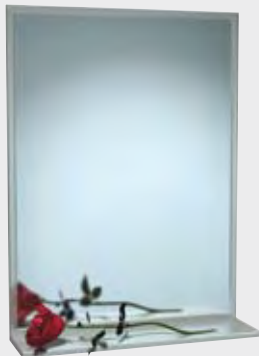

Frame and shelf fabricated of grade 304 stainless steel and channel is a one piece roll formed member that encases mirror and backing revealing a tight mitered corner.

*Refer to JD MacDonalD specification sheet to view standard sizes available.*

JD MacDonalD reserves the right to, and does from time to time, make changes and improvements in design and dimensions. The photographs & descriptions of the products in this catalogue are representational only. All dimensions are in millimetres.

Freecall 1800 023 441 or phone your nearest JD MacDonalD Sales Office

Adelaide (08) 8168 2222, Brisbane (07) 3363 6400, Melbourne (03) 9271 6400, Perth (08) 9271 8455, Sydney (02) 9756 1622

A Division of MacDonalD Johnston Pty Ltd 65-73 Nantilla Road, Clayton North, Victoria 3168 Tel (03) 9271 6400 Fax (03) 9271 6485

8026

Frameless Stainless Steel Mirror

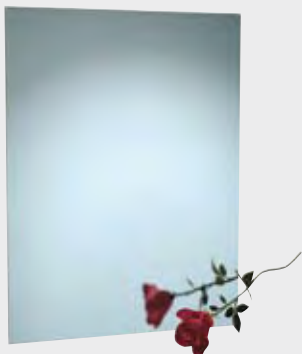

Fabricated of grade 304 stainless steel polished to a No. 8 mirror finish. Provided with 6mm thick concealed tempered masonite backing and four mounting holes.

*Refer to JD MacDonald specification sheet to view standard sizes available.*

20650B

Angle Frame Mirror with Tempered Glass (Roval Collection)



Angle frame mirror shall be fabricated of 18 gauge grade 304 stainless steel alloy 18-8 and have tempered glass.

*Refer to JD MacDonald specification sheet to view standard sizes available.*

JD MacDonald reserves the right to, and does from time to time, make changes and improvements in design and dimensions. The photographs & descriptions of the products in this catalogue are representational only. All dimensions are in millimetres.

Freecall 1800 023 441 or phone your nearest JD MacDonald Sales Office

Adelaide (08) 8168 2222, Brisbane (07) 3363 6400, Melbourne (03) 9271 6400, Perth (08) 9271 8455, Sydney (02) 9756 1622

A Division of MacDonald Johnston Pty Ltd 65-73 Nantilla Road, Clayton North, Victoria 3168 Tel (03) 9271 6400 Fax (03) 9271 6485

# COMMERCIAL WASHROOM ACCESSORIES

## Shower & Grab Rails



GR00 (300-2000) Toilet Grab Rail



Fabricated of grade 304 stainless steel and shall have concealed flanges.  
Sizes available from 300 to 2000mm.

GR05 Toilet Grab Rail



Fabricated of grade 304 stainless steel and shall have concealed flanges with bent 90 degree angle.

GR06 Toilet Grab Rail



Fabricated of grade 304 stainless steel and shall have concealed flanges with bent 40 degree angle.

JD Macdonald reserves the right to, and does from time to time, make changes and improvements in design and dimensions.  
The photographs & descriptions of the products in this catalogue are representational only. All dimensions are in millimetres.

Freecall 1800 023 441 or phone your nearest JD Macdonald Sales Office

Adelaide (08) 8168 2222, Brisbane (07) 3363 6400, Melbourne (03) 9271 6400, Perth (08) 9271 8455, Sydney (02) 9756 1622

A Division of Macdonald Johnston Pty Ltd 65-73 Nantilla Road, Clayton North, Victoria 3168 Tel (03) 9271 6400 Fax (03) 9271 6485

GRC53

Toilet Grab Rail



Fabricated of grade 304 stainless steel and shall have concealed flanges, two piece set for exposed cisterns. Main piece bent 90 degree angle. 300mm straight grab rail included.

GRC63

Toilet Grab Rail



Fabricated of grade 304 stainless steel and shall have concealed flanges, two piece set for exposed cisterns. Main piece bent 40 degree angle. 300mm straight grab rail included.

GRC-AM45

Toilet Grab Rail



Fabricated of grade 304 stainless steel and shall have concealed flanges. Two units equal one set.

JD MacDonald reserves the right to, and does from time to time, make changes and improvements in design and dimensions. The photographs & descriptions of the products in this catalogue are representational only. All dimensions are in millimetres.

Freecall 1800 023 441 or phone your nearest JD MacDonald Sales Office

Adelaide (08) 8168 2222, Brisbane (07) 3363 6400, Melbourne (03) 9271 6400, Perth (08) 9271 8455, Sydney (02) 9756 1622

A Division of MacDonald Johnston Pty Ltd 65-73 Nantilla Road, Clayton North, Victoria 3168 Tel (03) 9271 6400 Fax (03) 9271 6485

# COMMERCIAL WASHROOM ACCESSORIES

## Shower & Grab Rails



GR01/90

Toilet Grab Rail



Fabricated of grade 304 stainless steel for concealed cistern and shall have concealed flanges with bent 90 degree angle.

GR01/40

Toilet Grab Rail

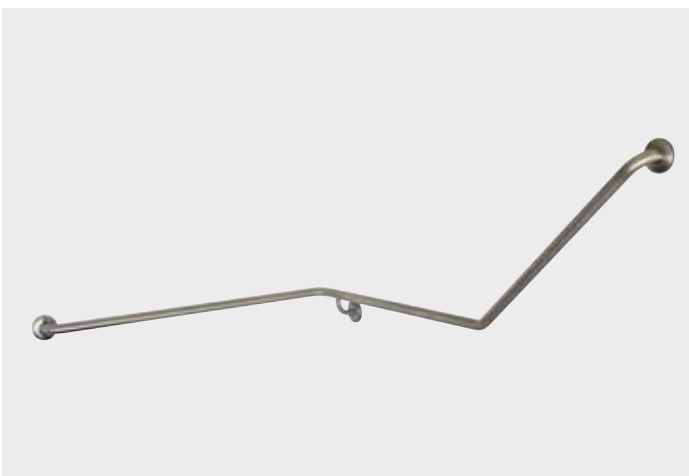

Fabricated of grade 304 stainless steel for concealed cisterns and shall have concealed flanges with bent 40 degree angle.

GR20

Toilet Grab Rail



Fabricated of grade 304 stainless steel and shall have drop down grab rail.

JD Macdonald reserves the right to, and does from time to time, make changes and improvements in design and dimensions. The photographs & descriptions of the products in this catalogue are representational only. All dimensions are in millimetres.

Freecall 1800 023 441 or phone your nearest JD Macdonald Sales Office

Adelaide (08) 8168 2222, Brisbane (07) 3363 6400, Melbourne (03) 9271 6400, Perth (08) 9271 8455, Sydney (02) 9756 1622

A Division of Macdonald Johnston Pty Ltd 65-73 Nantilla Road, Clayton North, Victoria 3168 Tel (03) 9271 6400 Fax (03) 9271 6485

# COMMERCIAL WASHROOM ACCESSORIES

## Shower & Grab Rails



GR27

Shower Grab Rail

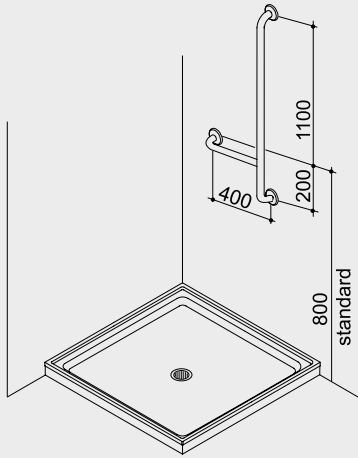

Fabricated of grade 304 stainless steel and shall have concealed flanges.

GR29

Shower Grab Rail



Fabricated of grade 304 stainless steel and shall have 'T' shape grab rail and concealed flanges.

GR34

Shower Grab Rail



Fabricated of grade 304 stainless steel and shall have concealed flanges.

JD MacDonald reserves the right to, and does from time to time, make changes and improvements in design and dimensions. The photographs & descriptions of the products in this catalogue are representational only. All dimensions are in millimetres.

Freecall 1800 023 441 or phone your nearest JD MacDonald Sales Office

Adelaide (08) 8168 2222, Brisbane (07) 3363 6400, Melbourne (03) 9271 6400, Perth (08) 9271 8455, Sydney (02) 9756 1622

A Division of MacDonald Johnston Pty Ltd 65-73 Nantilla Road, Clayton North, Victoria 3168 Tel (03) 9271 6400 Fax (03) 9271 6485

# COMMERCIAL WASHROOM ACCESSORIES

## Shower & Grab Rails



GR09

Toilet Grab Rail



Fabricated of grade 304 stainless steel and shall have moveable outrigger and concealed flanges.

GRCS01/40

Toilet Grab Rail Clean Seal

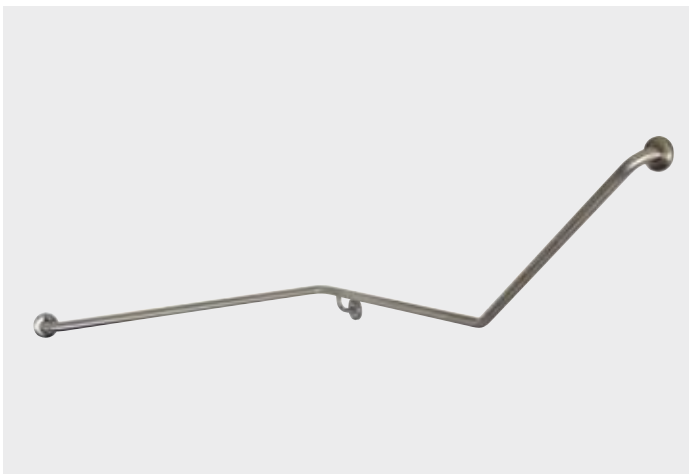

Fully welded construction is finished in satin stainless steel tubing and double chrome plated innovative flange and cover system with hygienically sealed installation with silicone 'O' rings. 40 degree angle.

GRCS01/90

Toilet Grab Rail Clean Seal



Fully welded construction is finished in satin stainless steel tubing and double chrome plated innovative flange and cover system with hygienically sealed installation with silicone 'O' rings. 90 degree angle.

JD Macdonald reserves the right to, and does from time to time, make changes and improvements in design and dimensions. The photographs & descriptions of the products in this catalogue are representational only. All dimensions are in millimetres.

Freecall 1800 023 441 or phone your nearest JD Macdonald Sales Office

Adelaide (08) 8168 2222, Brisbane (07) 3363 6400, Melbourne (03) 9271 6400, Perth (08) 9271 8455, Sydney (02) 9756 1622

A Division of Macdonald Johnston Pty Ltd 65-73 Nantilla Road, Clayton North, Victoria 3168 Tel (03) 9271 6400 Fax (03) 9271 6485

# COMMERCIAL WASHROOM ACCESSORIES

## Shower & Grab Rails



GRCS05

Toilet Grab Rail Clean Seal



Fully welded construction is finished in satin stainless steel tubing and double chrome plated innovative flange and cover system with hygienically sealed installation with silicone 'O' rings. 90 degree angle.

GRCS06

Toilet Grab Rail Clean Seal



Fully welded construction is finished in satin stainless steel tubing and double chrome plated innovative flange and cover system with hygienically sealed installation with silicone 'O' rings. 40 degree angle.

GRCS300

Toilet Grab Rail Clean Seal



Fully welded construction is finished in satin stainless steel tubing and double chrome plated innovative flange and cover system with hygienically sealed installation with silicone 'O' rings. 300mm straight.

JD Macdonald reserves the right to, and does from time to time, make changes and improvements in design and dimensions. The photographs & descriptions of the products in this catalogue are representational only. All dimensions are in millimetres.

Freecall 1800 023 441 or phone your nearest JD Macdonald Sales Office

Adelaide (08) 8168 2222, Brisbane (07) 3363 6400, Melbourne (03) 9271 6400, Perth (08) 9271 8455, Sydney (02) 9756 1622

A Division of Macdonald Johnston Pty Ltd 65-73 Nantilla Road, Clayton North, Victoria 3168 Tel (03) 9271 6400 Fax (03) 9271 6485

# COMMERCIAL WASHROOM ACCESSORIES

## Shower & Grab Rails



GRC600

Toilet Grab Rail Clean Seal



Fully welded construction is finished in satin stainless steel tubing and double chrome plated innovative flange and cover system with hygienically sealed installation with silicone 'O' rings. 600mm straight.

GRCSES29

Shower Grab Rail Clean Seal with Easy Slider



Fully welded construction is finished in satin stainless steel tubing and double chrome plated innovative flange and cover system with hygienically sealed installation with silicone 'O' rings. Includes premium durable cast alloy cradle with fully adjustable sliding tension rail which is self cleaning.

GRCSES34

Shower Grab Rail Clean Seal with Easy Slider



Fully welded construction is finished in satin stainless steel tubing and double chrome plated innovative flange and cover system with hygienically sealed installation with silicone 'O' rings. Includes premium durable cast alloy cradle with fully adjustable sliding tension rail which is self cleaning.

JD MacDonalD reserves the right to, and does from time to time, make changes and improvements in design and dimensions. The photographs & descriptions of the products in this catalogue are representational only. All dimensions are in millimetres.

Freecall 1800 023 441 or phone your nearest JD MacDonalD Sales Office

Adelaide (08) 8168 2222, Brisbane (07) 3363 6400, Melbourne (03) 9271 6400, Perth (08) 9271 8455, Sydney (02) 9756 1622

A Division of MacDonalD Johnston Pty Ltd 65-73 Nantilla Road, Clayton North, Victoria 3168 Tel (03) 9271 6400 Fax (03) 9271 6485

# COMMERCIAL WASHROOM ACCESSORIES

## Shower & Grab Rails



GRCSES800 Shower Grab Rail Clean Seal with Easy Slider



Fully welded construction is finished in satin stainless steel tubing and double chrome plated innovative flange and cover system with hygienically sealed installation with silicone 'O' rings. Includes premium durable cast alloy cradle with fully adjustable sliding tension rail which is self cleaning, and a chrome shower kit model GRSS-SKI.

GRSS-SK1 Shower Grab Rail Clean Seal



Shower kit includes handset, hose, non-return valve and wall outlet - chrome plated.

8203-M-AU Folding Phenolic Shower Seat



Fabricated of grade 304 stainless steel with 8mm thick, one piece, solid Phenolic, ivory coloured seat. Features a self-locking mechanism. Overall size: 960 x 400mm.

JD Macdonald reserves the right to, and does from time to time, make changes and improvements in design and dimensions. The photographs & descriptions of the products in this catalogue are representational only. All dimensions are in millimetres.

Freecall 1800 023 441 or phone your nearest JD Macdonald Sales Office

Adelaide (08) 8168 2222, Brisbane (07) 3363 6400, Melbourne (03) 9271 6400, Perth (08) 9271 8455, Sydney (02) 9756 1622

A Division of Macdonald Johnston Pty Ltd 65-73 Nantilla Road, Clayton North, Victoria 3168 Tel (03) 9271 6400 Fax (03) 9271 6485

# COMMERCIAL WASHROOM ACCESSORIES

## Shower & Grab Rails



SS960

Folding Acrylic Shower Seat



Fabricated of grade 304 stainless steel with solid white acrylic deck.  
Overall size: 960 x 400mm.

**SS960A** (not shown) similar to SS960, except deck is aluminium slats, powder coated white.

**SS600** (not shown) similar to SS960, except not disabled compliant to Australian standards.  
Overall size: 600 x 400mm.

JDMTRACK

Shower Curtain Tracks



Fabricated of Aluminium and shall be powder coated white. Various straight and 'L' shape lengths available. Comes with hooks.

*Refer to JD MacDonald specification sheet to view standard sizes available.*

JDMROD

Shower Curtain Rods



Fabricated of grade 304 stainless steel and is available with fixed end flanges or loose end flanges. Various straight and 'L' shape lengths available.

*Refer to JD MacDonald specification sheet to view standard sizes available.*

JD MacDonald reserves the right to, and does from time to time, make changes and improvements in design and dimensions. The photographs & descriptions of the products in this catalogue are representational only. All dimensions are in millimetres.

Freecall 1800 023 441 or phone your nearest JD MacDonald Sales Office

Adelaide (08) 8168 2222, Brisbane (07) 3363 6400, Melbourne (03) 9271 6400, Perth (08) 9271 8455, Sydney (02) 9756 1622

A Division of MacDonald Johnston Pty Ltd 65-73 Nantilla Road, Clayton North, Victoria 3168 Tel (03) 9271 6400 Fax (03) 9271 6485

[www.jdmacdonald.com.au](http://www.jdmacdonald.com.au)

# COMMERCIAL WASHROOM ACCESSORIES

## Shower & Grab Rails



1200-SHU

Shower Curtain Hooks



Fabricated of grade 304 stainless steel and shall be for rods 25mm and 32mm diameter.

JDMCURT-NT

Shower Curtains



Fabricated of Nylon Taffeta, white and weighted. 8 hooks shall be required per meter.

*Refer to JD MacDonald specification sheet to view standard sizes available.*

JDMCURT-BSP

Shower Curtains



Fabricated of Box Stripe Polyester, white and weighted. 8 hooks shall be required per meter.

*Refer to JD MacDonald specification sheet to view standard sizes available.*

JD MacDonald reserves the right to, and does from time to time, make changes and improvements in design and dimensions. The photographs & descriptions of the products in this catalogue are representational only. All dimensions are in millimetres.

Freecall 1800 023 441 or phone your nearest JD MacDonald Sales Office

Adelaide (08) 8168 2222, Brisbane (07) 3363 6400, Melbourne (03) 9271 6400, Perth (08) 9271 8455, Sydney (02) 9756 1622

A Division of MacDonald Johnston Pty Ltd 65-73 Nantilla Road, Clayton North, Victoria 3168 Tel (03) 9271 6400 Fax (03) 9271 6485