



SPECIFICATION

Clean seal fully welded construction is finished in satin stainless steel tubing with double chrome plated innovative flange and cover system. Simple fixing method with a hygienically sealed installation with silicone 'o' ring seals. Designed for the safety, security and convenience of the physically disabled. Easy to install on most building surfaces. Tubing diameter is 32mm.

OPTIONS

JD MacDonald can also supply the tubing in a high polish stainless steel.

RECOMMENDED INSTALLATION HEIGHT

To comply with Australian Standards AS 1428.1, grab rails must be fastened a minimum distance of 800mm from the floor, with 600mm of clear space above the rail and to withstand a force of 1100N at any point from any direction.

WARRANTY

Grab Rail products distributed by JD MacDonald are guaranteed to be free from defective materials and workmanship for 12 months from the date of purchase, subject to product being installed and maintained in accordance with the Installation and Operating instructions (fixings supplied by others). Products returned to JD MacDonald under this warranty will be, at the option of the company, repaired or replaced at no charge to the purchaser.

Grab Rail GRCS0140 (left hand model shown) shall be Model No. GRCS0140 and shall be 1100mm x 900mm horizontal x 700mm vertical at a 40 degree bent angle as supplied by JD MacDonald.

 All JD MacDonald disabled compliant products when installed must be in accordance with AS1428 to ensure the specified product is complying with all washroom specification requirements.

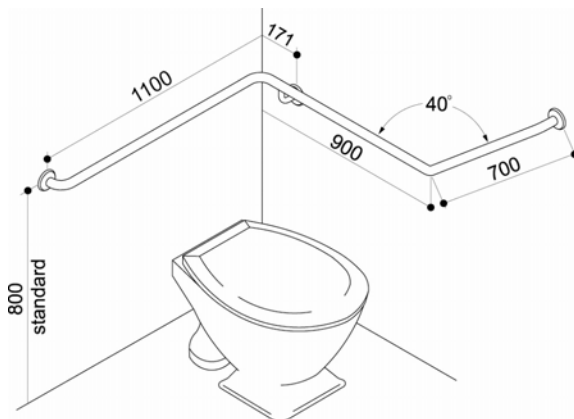

- Effectively sealed to inhibit bacteria
- Easy ¼ turn flange cover installation
- Silicone 'o-ring' seals